

DTP-125UL MANUAL TENSIONER

GENERAL SAFETY CONSIDERATIONS

1. **EYE INJURY HAZARD.**
Failure to wear safety glasses with side shields can result in severe eye injury or blindness. Always wear safety glasses with side shields which conform to ANSI Standard Z87.1.

2. **STRAP BREAKAGE HAZARD.**
Improper operation of the tool or sharp corners on the load can result in strap breakage during tensioning, which could result in the following:

- A sudden loss of balance causing you to fall.
- Both tool and strap flying violently towards your face.

Failure to place the strap properly around the load or on an unstable or shifted load could result in a sudden loss of strap tension during tensioning. This could result in a sudden loss of balance causing you to fall.

Read the tools operating instructions. If the load corners are sharp use edge protectors. Place the strap correctly around a properly positioned load.

Positioning yourself in-line with the strap, during tensioning and sealing, can result in severe personal injury from flying strap or tool. When tensioning or sealing, position yourself to one side of the strap and keep all bystanders away.

3. **FALL HAZARD.**
Maintaining improper footing and/or balance when operating the tool can cause you to fall. Do not use the tool when you are in an awkward position.

4. **CUT HAZARD.**
Handling strap or sharp parts could result in cut hands or fingers. Wear protective gloves.

5. **TRAINING.**
This tool must not be used by persons not properly trained in their use. Be certain that you receive proper training from your employer. If you have any questions contact your Acme Representative.

6. **TOOL CARE.**
Take good care of the tool. Inspect and clean it daily, lubricate it weekly and adjust when necessary. Replace any worn or broken parts.

7. **WORK AREA.**
Keep work areas uncluttered and well lighted.

STRAP SPECIFICATIONS

Width: 3/4" to 1-1/4" Steel
Gauge: .025 to .035" Thick

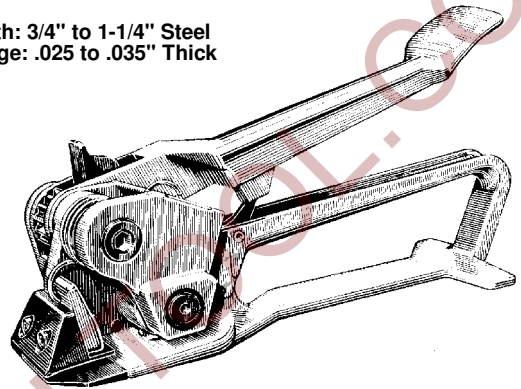

OPERATING INSTRUCTIONS

1. Thread the strap through the seal. Encircle the bundle and thread the strap through the seal again. Bend the lower strap back sharply beneath the seal and pull out all slack strap.

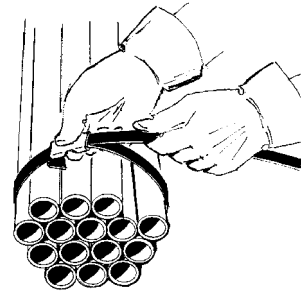

2. Squeeze the handles together to lift the feedwheel. Insert the strap into the slot of the breaker nose and push the tool up against the seal.

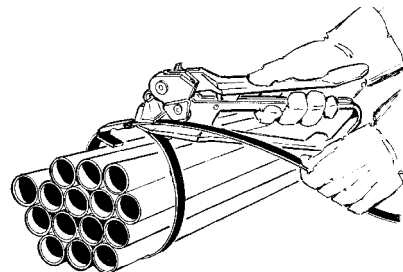

OPERATING INSTRUCTIONS, Continued

3. Stand to one side of the strap line and tension the strap with forward and backward motions of the tension handle.

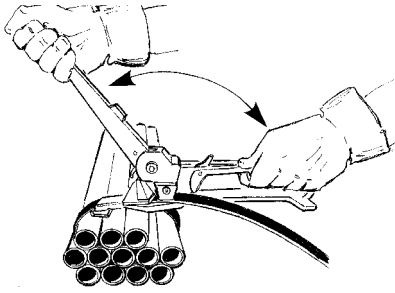

4. When desired tension is reached, push the drive pawl forward and rotate the tension handle back to contact the lift arm.

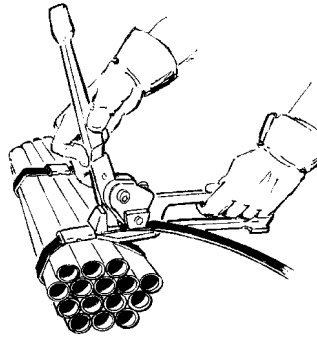

5. Notch the seal with a Delta sealer to complete the joint.

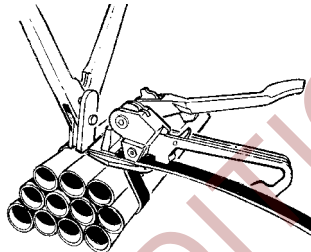

6. Break off the strap at the seal by raising the tool perpendicular to the seal, then lowering it.

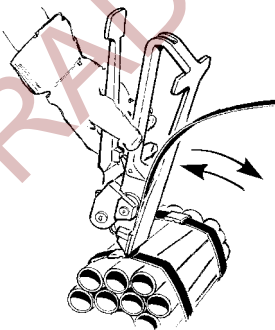

WARNING

Inspect all parts daily and replace them if they are worn or broken. Failure to do this can affect a product's operation and could result in serious personal injury.

PARTS LIST

KEY	QTY.	PART#	DESCRIPTION
1	1	014809	Roll pin, .093 x 1.000
2	1	017959	Drive pawl
3	1	017946	Drive pawl spring
4	1	306148	Tension handle
5	1	017945	Pawl pin
6	1	017925	Pinion gear
7	1	017926	Tension gear
8	1	017929	Bushing
9	1	017947	Feedwheel shaft
10	1	041912	BHCS, #10-24 x 3/8
11	1	184501	Washer, 3/16 SAE
12*	1	043982	BHCS, 5/16-24 x 1/2
13	1	004959	Washer, 5/16 SAE
14	1	017943	Hold pawl
15	1	306147	Gear housing
16	2	017944	Hold pawl spring
17	1	017937	Pivot pin
18	1	020517	Feedwheel
19	1	017941	Lift arm
20*	1	001656	Strap guide pin
21	1	017935	Breaker nose
22*	2	007878	SHCS, 1/4-28 x 3/4
23	1	097526	Roll pin, 1/4 x 7/8
24	1	017939	Wear plug
25	1	017952	Lock wire
26	1	017942	Base spring
27	1	003133	Danger sign
28	1	306149	Base
29	1	017955	Nameplate
31	1	424035	Bushing
32	1	020694	Set screw

When ordering parts, please show tool model, part number and name. All recommended spare parts are underlined and should be stocked. Standard hardware parts may be obtained from local hardware suppliers.

For Parts Support Call 1-866-862-6699

* Apply one drop of Loctite #271 (Red) or equivalent.

