

DTW-208 & DTW-210 TENSIONERS

DTW-208 (Part No. 306165) • DTW-210 (Part No. 306175)

GENERAL SAFETY CONSIDERATIONS

1. Before using tool read its operation instructions.
2. Several combinations of strap and seals can be used with this tool. Use the correct Acme products for your application. If you need help, contact your local Acme representative.
3. Wear eye and hand protection.
4. Keep work areas uncluttered and well lighted.
5. Take good care of the tool. Inspect and adjust it daily. Replace worn or broken parts. Clean and lubricate it weekly.
6. Seals must be properly crimped or notched. Follow the operating instructions in this manual.
7. Retract strap end back into dispenser when not in use.

SAFETY PROCEDURES FOR TOOL OPERATION

1. Follow the operating instructions.
2. Place strap properly around the load.
3. Make sure that the bottom strap is inserted under the gripper properly.

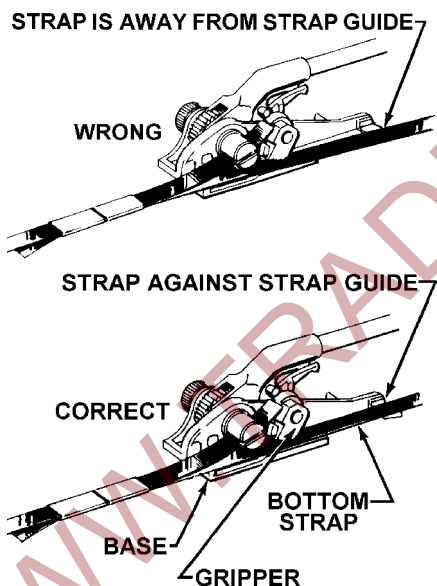

4. When tensioning or sealing, position yourself to one side of the strap.
5. Maintain proper footing and balance when operating tool.
6. Use short strokes on tensioning handle. Do not tension strap when you are in an awkward position.
7. The warning sign (shown below) is located on the handle of your tool and alerts you to the following:
 - Caution should be exercised when applying final tension as excessive tensioning can cause strap breakage.
 - Position yourself in such a manner that strap failure, or hands slipping off the handle will not cause loss of balance.
 - Never increase the length of the tensioning handle by any means, such as slipping a pipe over the handle to extend its length.
 - Read operation and safety instructions.



IF THIS SIGN BECOMES DAMAGED OR IS REMOVED FROM THE TOOL CONTACT ACME FOR A REPLACEMENT.

8. Apply tensions that are proper for the size and type of strap being used and is compatible with the loads being strapped and its corner characteristics. Determine such tensioning levels by trial, using proper operating procedures.
9. Tuck the strap end back into the strap dispenser when you are not using it.
10. It is advisable that safety belts be worn by operators working on high loads.

SAFETY PROCEDURE FOR CUTTING TENSIONED STRAP

1. Wear eye and hand protection.
2. Before cutting strap, make sure all bystanders are at a safe distance.
3. Stand clear of strap. Cut Strap.

TOOL SPECIFICATIONS

TOOL (Part No.)	STRAP		
	TYPE	WIDTH	THICKNESS
DTW-208 (306165)	HI TENSILE	1-1/4" Min.	.025" Min. to .050"
DTW-210 (306175)	HI TENSILE	2" Min.	.044" Min. to .050"

STRAP PLACEMENT AROUND LOAD

1. Place strap around load as shown in the illustrations.

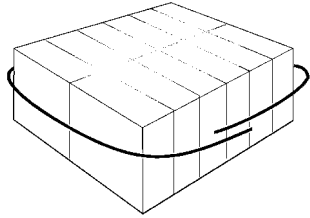

HORIZONTAL
STRAP SIDE LOAD

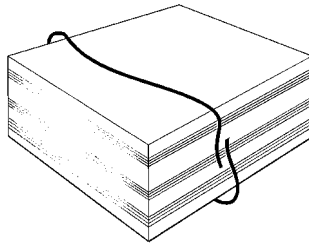

VERTICAL
STRAP SIDE LOAD

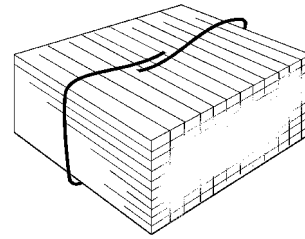

TOP
STRAP LOAD

WARNING

Failure to place the strap properly around the load or an unstable or shifted load could result in a sudden loss of strap tension during tensioning. This could result in a sudden loss of balance causing you to fall.

If the load corners are sharp use edge protectors. Failure to follow the above could result in serious injury or death.

With the DTW-208 tool, use only 1-1/4" wide (minimum) x .025" thick (minimum) hi tensile strap. With the DTW-210 tool, use only 2" wide (minimum) x .044" thick (minimum) hi tensile strap. Failure to use the proper tool or strap can result in serious personal injury.

2. Thread the proper number of heavy duty seals on both straps, Contact your sales representative for recommendations. Bend the lower/inner strap backwards to hold seals in place. Bend the upper/outer strap away from the load to permit insertion into the windlass of tensioner.

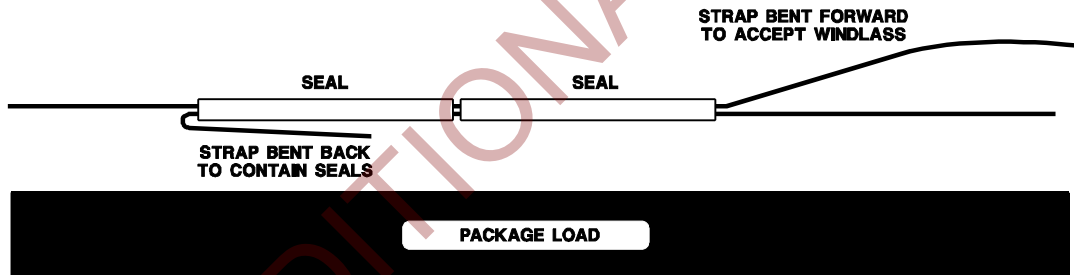

INSERTING STRAP INTO THE TOOL

1. Rotate the tensioning handle all the way down to lock the gripper in the open position. Adjust the drum so that the slot is in line with angle of strap.
2. Insert lower/inner strap in opening between gripper and base of tensioner until the strap is fully in contact with the inner wall of the base (strap guide). Make sure that the lower/inner strap is inserted over the base foot. Insert top/outer strap fully into windlass slot. Approximately 2 to 4 inches should extend beyond drum; cut off any excessive length before tensioning.

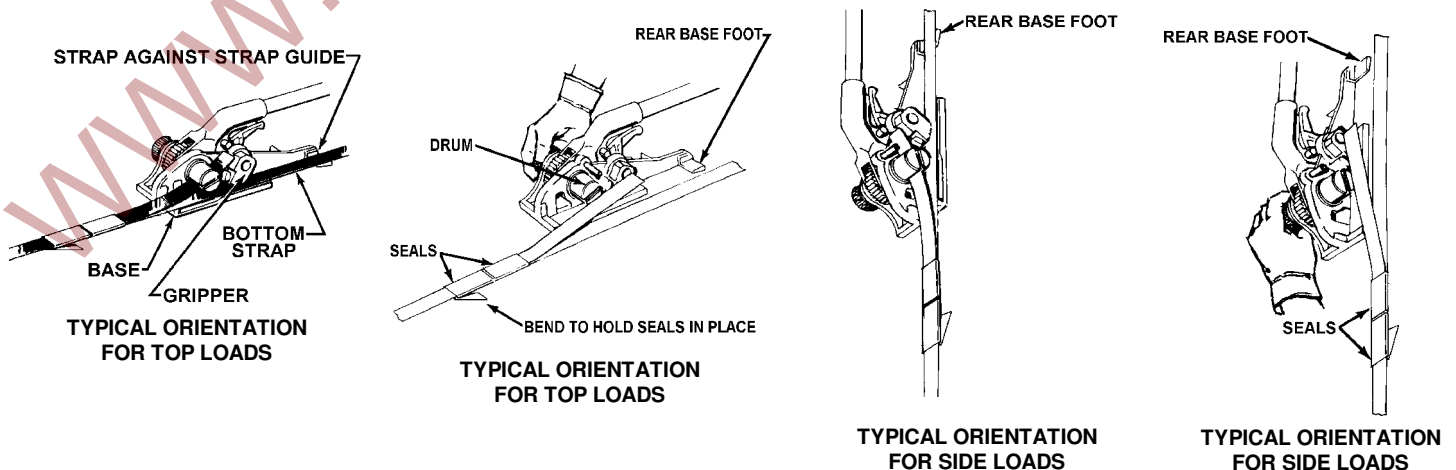

OPERATING INSTRUCTIONS

WARNING

While tensioning strap, do not rotate the tensioning handle to the point where it will contact the gripper release cam. This will result in a sudden loss of strap tension. Be careful when applying final tension, as excessive tension could cause strap breakage. Position yourself in such a manner that strap breakage or hands slipping off the handle will not cause a loss of balance. Never increase the length of the tensioning handle by any means, such as, slipping a pipe over the handle to extend its length. If you have any questions contact your sales representative.

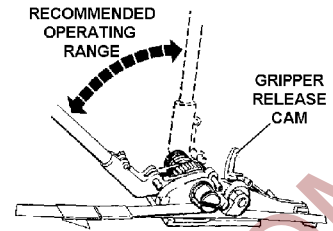

FOR ON TOP OF LOAD

1. Bring tensioning handle upward, allowing the gripper to contact the lower strap. Rotate tensioning handle back and forth to take up slack in strap. When strap is snug, the operator should kneel perpendicular to the strap and apply the final tension using short tensioning strokes.

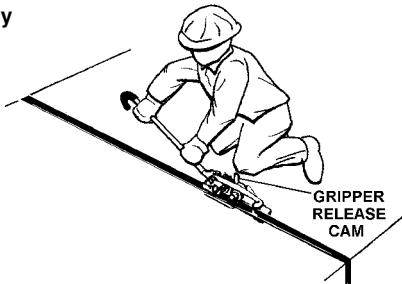

2. Open sealer fully and center sealer jaws of sealer over each seal. Crimp or notch each seal the proper number of times by bringing the top handle downward as far as it will go. Consult your sealer manual for the proper number of crimps or notches needed for your application.

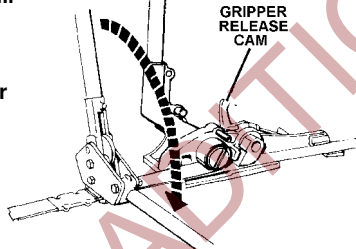

3. Release tensioner from strap by bringing handle down until gripper release cam locks in tensioning handle pin. Remove tensioner by twisting drum slot out of strap curl and sliding tool away from strap.

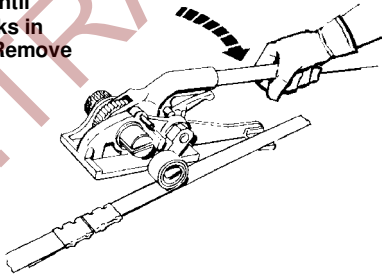

FOR WALL ANCHORED OR SIDE (HORIZONTAL) LOADS

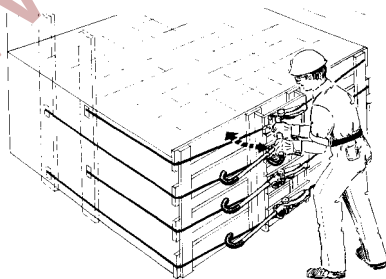

The positioning of the tensioner on the strap for horizontal use is the same as on the top of load operation. After the slack strap is taken up, final tension is applied by short push type strokes, as illustrated below. Note that a tensioner is used on each strap to ensure equal tension. The sealing operation is also the same as for top of load use (Refer to top of load instructions).

FOR ON SIDE OF LOAD (VERTICAL)

1. Bring tensioning handle downward, allowing the gripper to contact the lower strap. Rotate tensioning handle back and forth to take up slack in strap. When strap is snug, the operator should stand to the side of the tool and apply the final tension using short tensioning strokes.

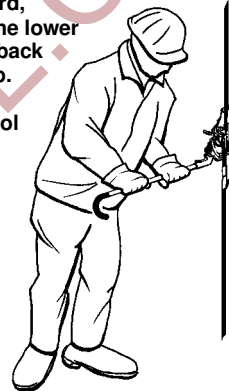

2. Open sealer fully and center sealer jaws of sealer over each seal. Crimp or notch each seal the proper number of times by bringing the top handle downward as far as it will go. Consult your sealer manual for the proper number of crimps or notches needed for your application.

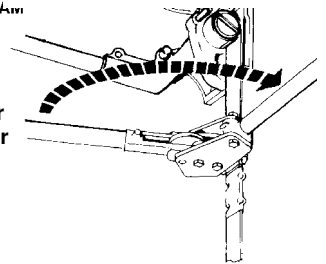

3. Release tensioner from strap by rotating handle until it contacts and locks into the gripper release cam. Remove tensioner by twisting drum slot out of strap curl and sliding tool away from strap.

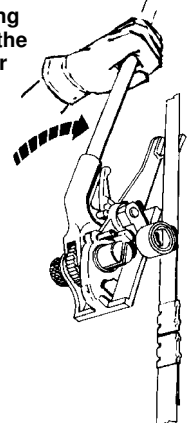

KEY	QTY	(306165) DTW-208 PART NO.	(306175) DTW-210 PART NO.	DESCRIPTION
1	1	171652	171652	Handle grip
2	1	306169	306179	Yoke handle assembly
3	2	173956	173956	Set screw, Nylock
5	1	006768	006768	Pawl pin
6	2	006767	006767	Pawl cam
7	1	086190	086190	Klipring, Truarc #5304-77
8	1	006746	006746	Pawl spring washer, 1/4 SAE Std.
9	2	006769	006769	Pawl spring
10	1	006711	006711	Handle pawl
11	1	006712	006712	Base pawl
12	1	006762	006762	Ratchet wheel
13	1	006920	-	Roll pin, 3/8 x 1 5/8
13A	1	-	071804	Roll pin, 3/8 x 2 1/4
14	1	005908	005909	Windlass shaft assembly
15	1	008675	008675	Bushing
16	1	008682	008682	Bushing
17	1	006705	006705	Windlass knob
18	1	006748	006748	Cap screw, 5/16-18 x 3/4
19	1	007184	007184	Retaining wire
20	1	006758	006758	Gripper
21	1	006787	006787	Roll pin, 3/16 x 1
22	1	006788	006788	Gripper spring
23	1	005907	005912	Gripper shaft
24	1	006765	006765	Gripper release
25	1	006738	006738	Roll pin, 5/32 x 1
26	1	006737	006737	Cam retaining pin (roll pin), 5/32 x 1
27	1	006739	006739	Cam push rod
28	1	006741	006741	Cam push rod spring
29	1	006742	006742	Gripper plate
30	A/R	005913	005913	Shim
31	2	004860	004860	Gripper plate screw
32	1	306167	-	Base
32A	1	-	306177	Base
33	1	-	006740	Push rod swivel
34	1	-	006698	Gripper stop pin
35	1	177896	177896	Warning sign
36	1	584-1101	584-1102	Nameplate

NOTES:

Assemble Keys 13, 15 & 16 with slots facing upwards

Thread wire (19) through hole in pin (14). Twist wire ends until snug. See Figure 1.

Clean tool at least once a week and apply light machine oil to all moving parts.

* Secure with Loctite #242.

