

SIGNODE®

**READ ALL SAFETY INSTRUCTIONS BEFORE
OPERATING THIS SIGNODE PRODUCT**

OPERATION, PARTS AND SAFETY MANUAL

It is the customer's responsibility to have all operators and servicemen read and understand this manual.

PF STRAP TENSIONER

Part No. 017900

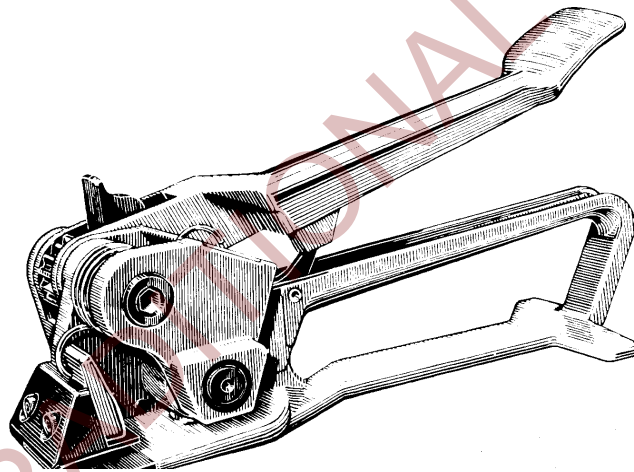

TOOL SPECIFICATIONS

STRAP TYPE	WIDTH	THICKNESS
Steel	3/8"(9.5mm) to 3/4" (19mm)	.015"(0.38mm) to .023"(0.58mm)

IMPORTANT - DO NOT DESTROY THIS MANUAL. It is the customer's responsibility to have all operators and service personnel read and understand this manual. Contact your local Signode representative for additional copies of this manual.

© Copyright 2003, Signode 186003 Rev. 7/2003

For Parts & Service 1-877-862-6699

WARNING

READ THESE INSTRUCTIONS CAREFULLY. FAILURE TO FOLLOW THESE INSTRUCTIONS CAN RESULT IN SERIOUS PERSONAL INJURY.

STRAP BREAKAGE HAZARD

Improper operation of the tool or sharp corners on the load can result in strap breakage during tensioning, which could result in the following:

- A sudden loss of balance causing you to fall.
- Both tool and strap flying violently towards your face.

Failure to place the strap properly around the load or an unstable or shifted load could result in a sudden loss of strap tension during tensioning. This could result in a sudden loss of balance causing you to fall.

- If the load corners are sharp use edge protectors.
- Positioning yourself in-line with the strap, during tensioning and sealing, can result in severe personal injury from flying strap or tool. When tensioning or sealing, position yourself to one side of the strap and keep all bystanders away.

TRAINING

This tool must not be used by persons not properly trained in its use. Be certain that you receive proper training from your employer. If you have any questions contact your Signode Representative.

EYE INJURY HAZARD

Failure to wear safety glasses with side shields can result in severe eye injury or blindness. Always wear safety glasses with side shields which conform to ANSI Standard Z87.1 or EN 166.



FALL HAZARD

Maintaining improper footing and/or balance when operating the tool can cause you to fall. Do not use the tool when you are in an awkward position.

CUT HAZARD

Handling strap or sharp parts could result in cut hands or fingers. Wear protective gloves.



TOOL CARE

- Inspect and clean the tool daily. Replace all worn or broken parts.
- Lubricate all moving parts weekly unless otherwise specified.

WORK AREAS

Keep work areas uncluttered and well lighted.

Use correct Signode products for your application. If you need help contact your Signode Representative.

Signode tools and machines are designed and warranted to work together with Signode strapping and seals. Use of non-Signode strap and seals and/or manufactured or specified replacement parts may result in strap breakage or joint separation while applying strapping to a load or during normal shipping and handling. This could result in severe personal injury.

SAFETY PROCEDURES FOR TOOL OPERATION

- Before using this tool, read its Operation and Safety Instructions contains in this manual.
- Tuck strap end back into the dispenser when not in use.

JOINT FORMATION

Never handle or ship any load with improperly formed joints. Misformed joints may not secure the load and could cause serious injury. Follow the joint inspection procedures in each sealers manual.

MOVING AND STACKING STRAPPED LOADS

Before moving or stacking any strapped load, follow all standard industry practices regarding safe material handling procedures.

CUTTING TENSIONED STRAP

Using claw hammers, crowbars, chisels, axes or similar tools will cause tensioned strap to fly apart with hazardous force. Use only cutters designed for cutting strap. Read the instructions in the cutter's manual for proper procedures in cutting strap. Before using any Signode product read its Operation and Safety Manual.

WARNING

Signode tools and machines are designed and warranted to work together with Signode strapping and seals. Use of non-Signode strap and seals and/or manufactured or specified replacement parts may result in strap breakage or joint separation while applying strapping to a load or during normal shipping and handling. This could result in severe personal injury.

OPERATING INSTRUCTIONS

⚠ WARNING

- Wear safety glasses which conform to ANSI Standard Z87.1 or EN 166.
- Stand to one side of the strap while tensioning. Make sure all bystanders are clear before proceeding.
- Failure to follow the above could result in serious personal injury.

1. Thread the strap through the seal. Encircle the bundle and thread the strap through the seal again. Bend the lower strap back beneath the seal, about 2", and pull out all slack strap.

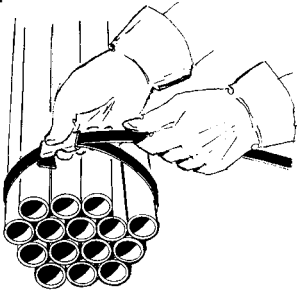

2. Squeeze the handles together to lift the feedwheel. Insert the strap into the slot of the breaker nose and push the tool up against the seal.

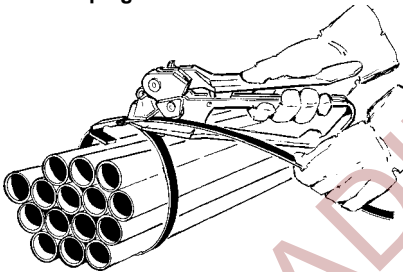

3. While standing to one side of the strap line, tension the strap with forward and backward motions of the tension handle.

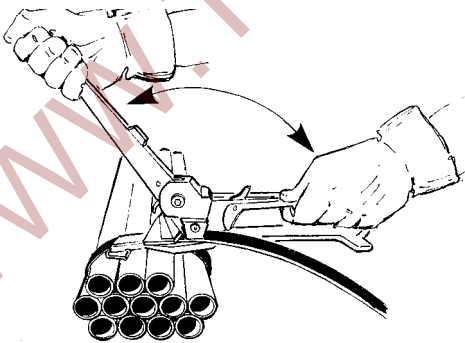

4. When desired tension is reached, push the drive pawl forward and rotate the tension handle back to contact the lift arm.

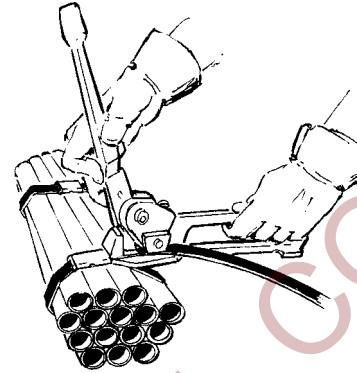

5. Notch the seal with a Signode sealer to complete the joint.

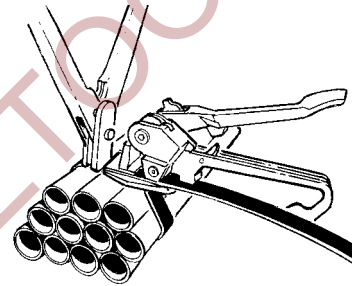

6. Break off the strap at the seal by repeatedly raising and lowering the tool. Inspect the joint to make sure the seal has been properly notched. Refer to the sealer Service Manual.

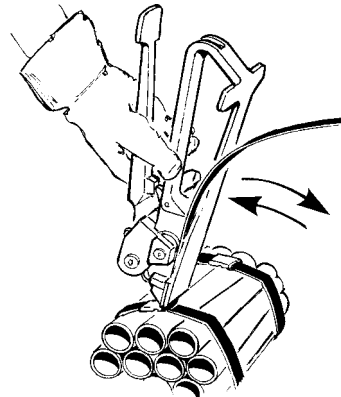

PARTS LIST, PF (017900)

KEY	QTY.	PART#	DESCRIPTION
1	1	014809	Roll pin, .093 x 1.000
2	1	017910	Drive pawl
3	1	017920	Drive pawl spring
4	1	<u>017904</u>	<u>Tension handle</u>
5	1	017919	Pawl pin
6	1	017912	Pinion gear
7	1	017911	Tension gear
8	1	017918	Bushing
9	2	023093	Woodruff key, #403
10	1	017922	Feedwheel shaft
11	1	003359	BHCS, 5/16-24 x 1/8
12	1	004959	Washer, 5/16 SAE
13	1	041912	BHSCS, #10-24x 3/8
14	1	023089	Washer, 3/16 SAE
15	2	<u>017915</u>	<u>Hold pawl</u>
16	1	017906	Gear housing
17	1	017921	Pivot pin
18	2	<u>017916</u>	<u>Hold pawl spring</u>
19	1	017923	Feedwheel
20	1	<u>001656</u>	<u>Strap guide pin</u>
21	1	017913	Lift arm
22	1	017908	Breaker nose
23	2	004618	SHCS, #10-24 x 5/8
24	1	005756	Roll pin, 3/16 x 3/4
25	1	<u>008777</u>	<u>Wear plug</u>
26	1	001644	Lock wire
27	1	017914	Base spring
28	1	003133	Caution sign
29	1	017902	Base
30	1	017936	Nameplate
31	1	424036	Bushing
32	1	020694	Set screw

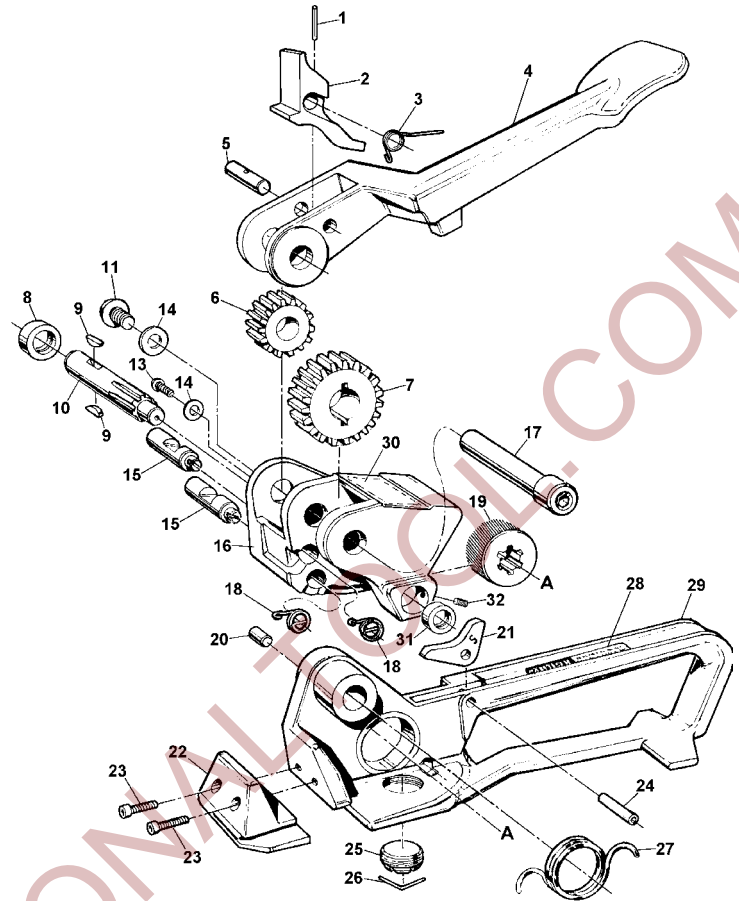

⚠ WARNING

Inspect all parts daily and replace them if they are worn or broken. Failure to do this can affect a product's operation and could result in serious personal injury.

NOTES:

1. When ordering parts, please show tool model, part number and name. All recommended spare parts are underlined and should be stocked. Standard hardware parts may be obtained from local hardware suppliers.
2. Slot in roll pin (24) must face down.
3. Assemble lift arm (21) with leg marked "S" as shown.

MAINTENANCE

Clean and apply a light weight machine oil to all moving parts on a weekly basis. Clean the feedwheel daily with a wire brush. Debris accumulated in the teeth of either the feedwheel or the clutch plug must be removed with a small wire brush. A need to clean the teeth will become apparent when either the feedwheel skids on the strap or the lower straps slips on the clutch plug during tensioning.